

NOTICE A CONSERVER MONTAGEANWEISUNG ZUM AUFBEWAHREN

F

- Contrôler le contenu de votre colis avant de procéder au montage.
- Ne détériorez pas l'emballage, il vous sera très utile pour protéger les éléments des coups et rayures pendant le montage.
- Assemblez ensuite le meuble en suivant l'ordre défini par la numérotation.
- En cas de problème contactez notre service après vente .
- Du fait de son confinement dans le carton après emballage, il est possible qu'au déballage et au montage votre produit dégage dans l'air des odeurs de vernis, plus ou moins prononcées. Afin que ces odeurs ne vous incommode pas, nous vous conseillons de disposer votre produit dans une pièce convenablement et régulièrement aérée, en ouvrant complètement les portes et en déposant les tiroirs à côté du meuble, jusqu'à disparition de ces odeurs.

GB

- Check the content of your parcel before assembling.
- Do not throw away the packing which could be very useful to protect the panels from knocks and scratches when assembling.
- Assemble the article following the order of the numbers indicated.
- Should any problems arise, please contact our After Sales Service.
- You may notice a smell of varnish when you unpack your item, due to its having been stored in a box since its packaging. In order to avoid any inconvenience that may be caused by such odours, we recommend that you place the item in a well ventilated room, opening all doors, and removing the drawers from the cabinet, until any such odours have dissipated.

P

- Confira o conteúdo da sua encomenda antes de iniciar a montagem.
- Não danifique a embalagem, poderá ser-lhe útil para proteger os elementos de golpes ou riscos durante a montagem.
- Proceda à montagem do móvel seguindo a ordem definida pela numeração.
- Para qualquer esclarecimento, contacte os nossos serviços através do telefone.
- Devido ao seu encerramento na caixa de cartão após o acondicionamento, é possível que, no momento da desembalagem e montagem do produto, este lance para o ar um cheiro a verniz, mais ou menos intenso. Para que este cheiro não o incomode, aconselhamos-lhe a colocar o produto num compartimento adequado e regularmente arejado, deixando as portas totalmente abertas e colocando as gavetas ao lado do móvel, até que o referido cheiro desapareça..

S

- Controlar el contenido de su embalaje antes de proceder al montaje.
- No deteriorar el paquete, que le será muy útil para proteger los elementos de golpes y rozaduras durante el montaje..
- Acoplar de seguida el mueble, siguiendo la orden definida por la numeración.
- Si tiene problemas, contactar nuestro servicio postventa.
- Dado que el mueble ha permanecido encerrado en la caja de cartón desde el momento de su acondicionamiento, es posible que al desembalarlo desprenda a la atmósfera un olor a barniz más o menos pronunciado. Con el fin de evitar que esos olores sean para usted una incomodidad, le aconsejamos dejar el producto en un lugar adecuado y regularmente aireado; abrir por completo las puertas, retirar los cajones y dejarlos aireándose junto al mueble, hasta que tales olores hayan desaparecido.

G

- Vor Montage den Inhalt Ihres Päckchens kontrollieren.
- Die Verpackung nicht zerstören, sie wird Ihnen nützlich sein, um die Teile bei der Montage vor Stößen und Kratzern zu schützen.
- Das Möbel dann in der Reihenfolge der Nummerierung zusammenbauen.
- Im Problemfall Ihren Kundendienst anrufen.
- Da das Möbelstück eine gewisse Zeit lang eng verpackt war, ist nicht auszuschließen, dass sich beim Auspacken und der Montage ein mehr oder minder starker Lackgeruch entwickeln kann. Damit der Lackgeruch Sie nicht stört, empfehlen wir Ihnen, Ihren Einrichtungsgegenstand in einen gut und regelmäßig gelüfteten Raum zu stellen, die Schubladen herauszunehmen und die Türen ganz zu öffnen, bis sich der Lackgeruch vollständig verflüchtigt hat.

I

- Verificare il contenuto della confezione prima del montaggio.
- Non eliminare l'imballo che potrà essere utilizzato per proteggere il prodotto dai danni durante il montaggio.
- Montare l'articolo seguendo l'ordine di numerazione.
- In caso di necessità contattare il nostro servizio post-vendita.
- Per il fatto di essere rimasto chiuso nel cartone dopo l'imballaggio, è possibile che il mobile una volta liberato dal cartone e durante il montaggio sprigioni nell'aria odori di vernice più o meno forti. Affinché questi odori non Le creino fastidio, raccomandiamo di collocare il prodotto in un locale adeguatamente e regolarmente aerato, aprendo completamente le porte e depositando i cassetti accanto al mobile fino alla scomparsa degli odori.

D

- De inhoud van uw pakket controleren alvorens met de montage te beginnen.
- De verpakking niet beschadigen, deze kan heel handig zijn om de onderdelen te beschermen tegen schokken en krassen tijdens de montage.
- Zet vervolgens het meubel in elkaar in de volgorde die is bepaald in de nummering.
- Neem bij problemen contact op met onze klantenservice.
- Het is mogelijk dat zich bij het uitpakken en in elkaar zetten van uw product een min of meer uitgesproken laklucht verspreidt. Om te voorkomen dat u last heeft van deze lucht, raden we u aan om uw product in een voldoende en regelmatig geventileerde ruimte neer te zetten. Doe daarbij de deurtjes helemaal open en zet de laden naast het meubel neer totdat deze lucht is verdwenen.

FI

- Tarkista pakkauksen osat ennen kokoamisen aloittamista.
- Älä hajota pakkausta. Se on hyödyllinen kokoamisen yhteydessä osien suojaamiseksi naarmulta.
- Kokoa huonekalu seuraamalla ohjeita numerojärjestyksessä.
- Ongelman tapauksessa, ottakaa yhteys jälkimyyntipalveluumme.
- On mahdollista, että tuote avaamisen ja kokoamisen yhteydessä vapauttaa ilkan hajua johtuen sen säilytyksestä pakkauksen sisässä. Jotta tämä hajua ei häiritسی teitä, suosittelemme asettamaan tuotteen kunnolla ilmastoituun tilaan, avaamaan sen ovet ja irrottamaan laatikot, kunnes hajua ei kadonnut.

SE

- Kontrollera innehållet i förpackningen innan du påbörjar monteringen.
- Förstör inte förpackningen, eftersom den kan användas till att skydda delarna från stöt och repor under monteringen.
- Montera därefter möbelen i den ordning som anges med nummeringen.
- Om problem uppstår, kontakta vår kundtjänst.
- Det kan hända att det under upppackning eller monterig frigörs mer eller mindre tydliga dofter av ytbehandlingsmedel från produkten. För att du inte ska besväras av dessa dofter råder vi dig att ställa produkten i ett välventilerat rum, öppna dörrarna helt och placera lådorna vid sidan av möbelen, till dess att dofterna försvunnit.

Informations à conserver / Keep this information for future reference / Informa o a conservar / Guardar esta información para futuras referencias / Aufzubewahrende Informationen / Conservare le istruzioni per futuro utilizzo / Informatie om te bewaren / S ilytett v t tiedot / Ta vara p dessa anvisningar

- F** A monter par un adulte.
Attention: tenir les vis et petits éléments et sachets hors de portée des enfants.
bien identifier les éléments avant de commencer le montage.
Ne pas utiliser cet article comme échelle.
Ne pas utiliser votre article lorsque l'un de ses éléments est cassé ,endommagé ou manquant.
En cas de problème contactez notre service après vente.
- GB** To be assembled by an adult.
Caution: Keep all screws, small parts and plastic bags out of the reach of children.
Properly identify all parts before assembling.
Do not use this article as ladder.
Never use your item if any of its parts are broken ,damaged or missing.
Should any problems arise, please contact our After Sales Service.
- P** A ser montado por um adulto.
Precaução: Mantenha os parafusos, acessórios pequenos e saco de plástico fora do alcancedas crianças.
Identifique bem os acessórios antes de começar a montagem.
Nao utilizar este artigo como escadote.
Não utilizar o artigo se um dos elementos está em falta ou danificado.
Para qualquer esclarecimento, contacte os nossos serviços através do telefone.
- S** A montar por un adulto.
Atención: mantener los tornillos, los pequeños elementos y bolsitas fuera del alcance de los niños
Identificar debidamente los elementos antes de empezar el montaje.
No utilizar este artículo como escalera.
No utilizar este artículo si uno de los elementos falta o esta roto.
Si tiene problemas, contactar nuestro servicio postventa.
- G** Von einem Erwachsenen zu montieren.
Achtung: die Schrauben und kleinen Teile ausserhalb der Reichweite von Kindern lagern
Vor Montagebeginn alle Teile identifizieren.
Diesen Artikel nicht als Leiter benutzen.
Ihren Artikel nicht benutzen, wenn eines seiner Bestandteile beschädigt ist oder fehlt.
Im Problemfall Ihren Kundendienst anrufen.
- I** Il Montaggio deve essere eseguito da un adulto.
Attenzione! Tenere le viti ed i componenti di piccolo dimensioni lontano dalla portata dei bambini
Controllare i pezzi prima del montaggio.
Non utilizzare questo articolo a guisa di scala.
L'articolo non deve essere utilizzato in caso di elementi mancanti o danneggiati.
In caso di necessità contattare il nostro servizio post-vendita.
- D** Moet door een volwassene worden gemonteerd.
Waarschuwing: schroeven en kleine elementen en zakjes buiten bereik van kinderen houden
De elementen goed identificeren alvorens met de montage te beginnen.
Dit artikel niet als ladder gebruiken.
Uw artikel niet gebruiken wanneer een van de onderdelen kapot is of ontbreekt.
Neem bij problemen contact op met onze klantenservice.
- FI** Aikuisen koottava.
Varoitus: pidä ruuvit, pienet osat ja pussit poissa lasten ulottuvilta.
Tunnista osat ennen kokoamisen aloittamista.
Älä käytä tuotetta tikapuina.
Älä käytä tuotetta, jos jokin sen osista puuttuu tai on rikkoutunut.
Ongelman tapauksessa, ottakaa yhteys jälkimyyntipalveluumme.
- SE** Ska monteras av en vuxen.
Obs : Förvara skruvarna, smådelarna och påsarna utom räckhåll för barn.
Leta upp samtliga delar innan du börjar monteringen.
Ställ dig aldrig på denna produkt.
Använd aldrig denna produkt om någon del saknas eller är trasig.
Om problem uppstår, kontakta vår kundtjänst.

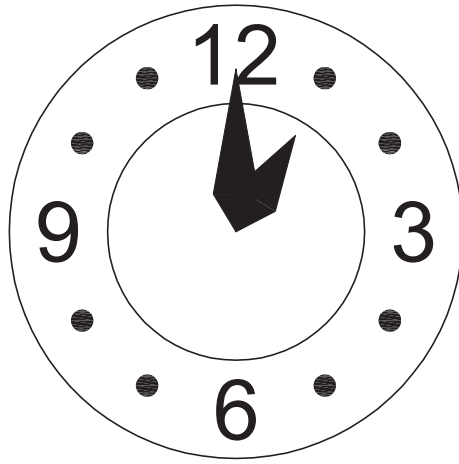

60 Min

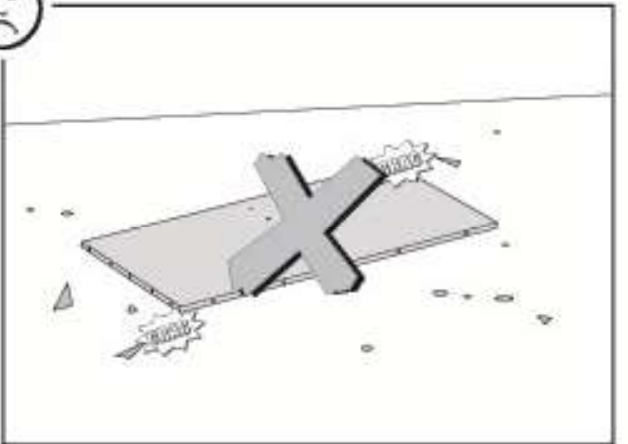
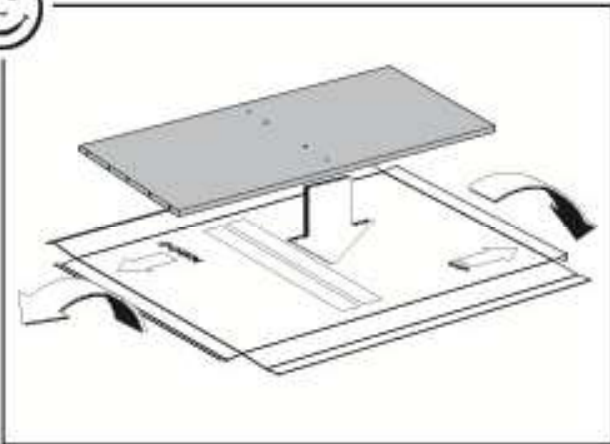
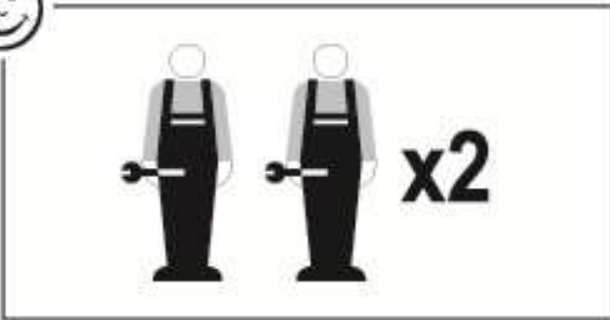
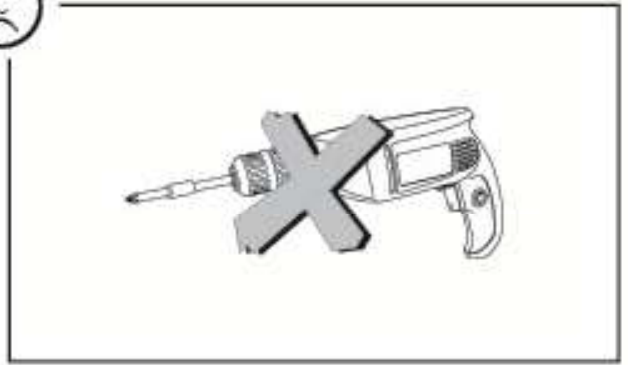
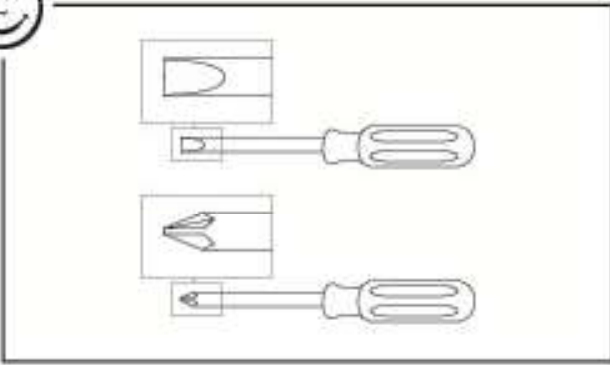

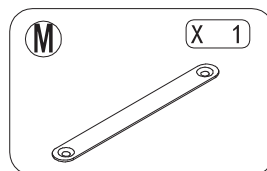
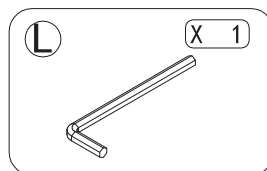
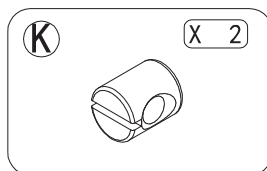
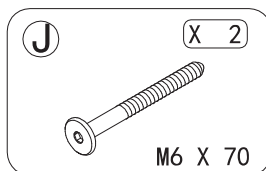
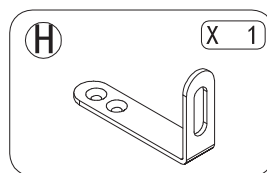
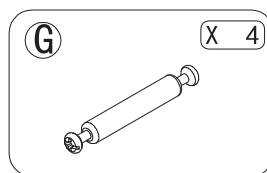
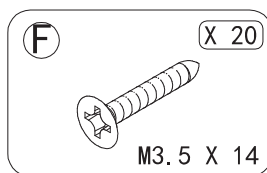
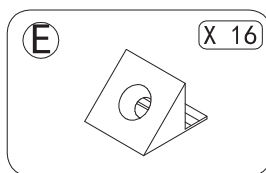
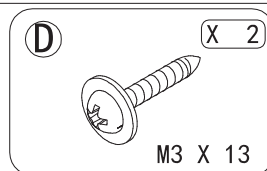
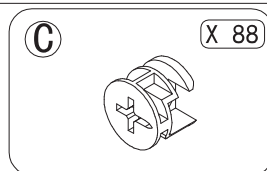
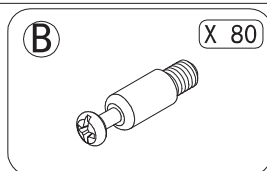
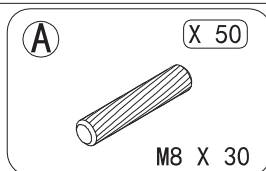
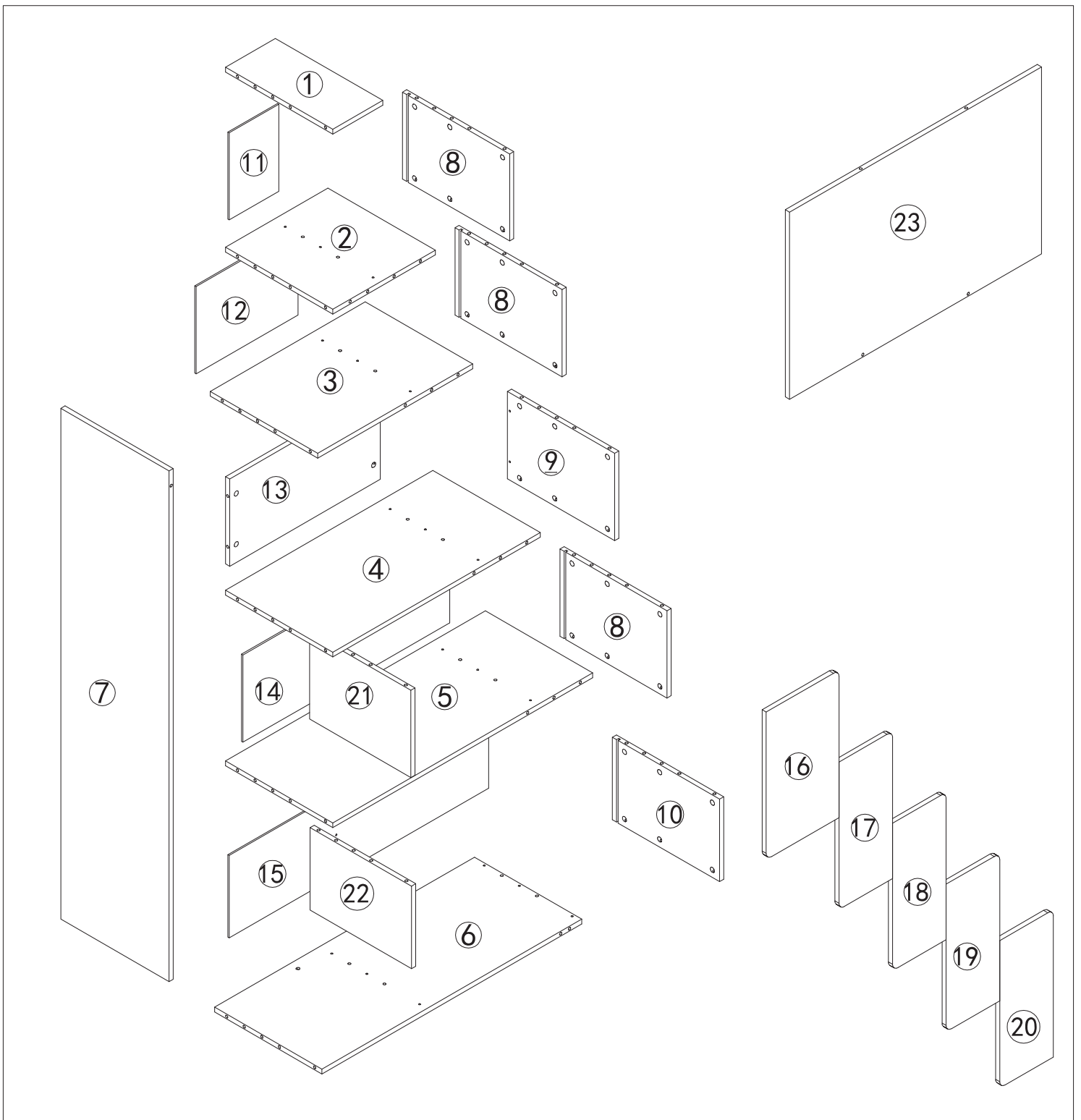

01

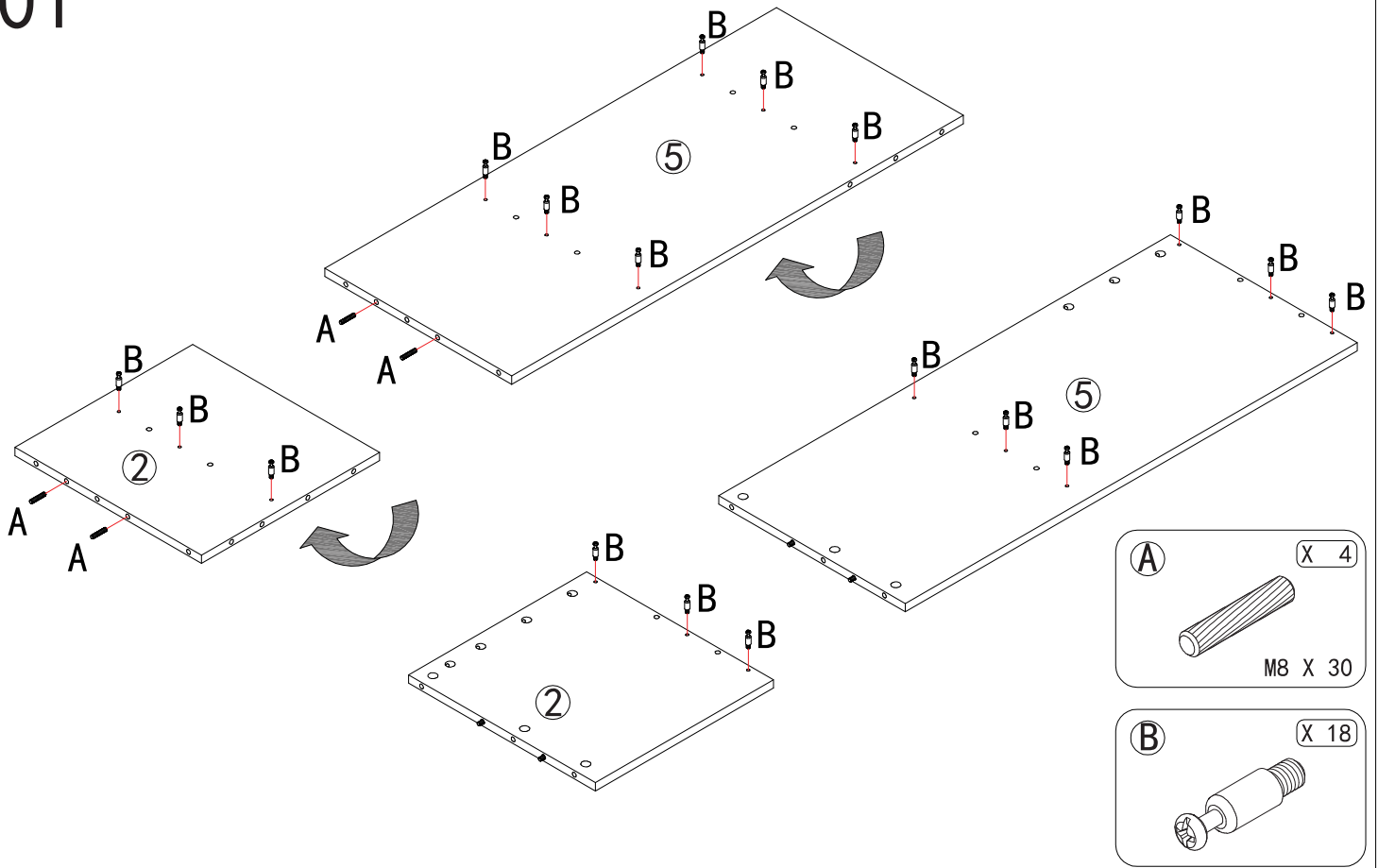

02

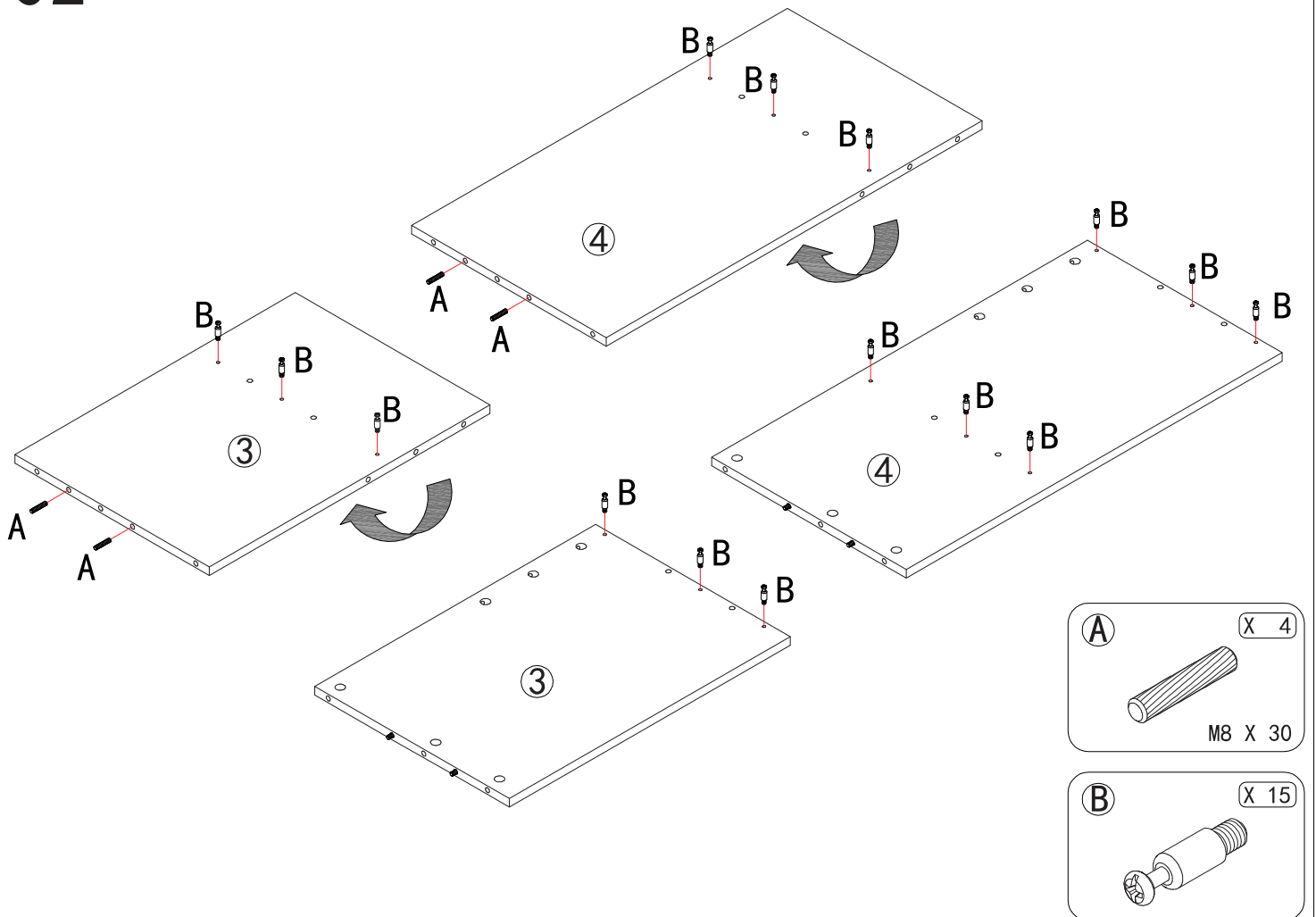

03

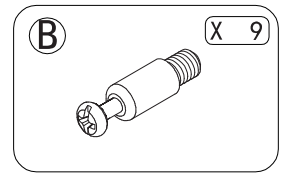
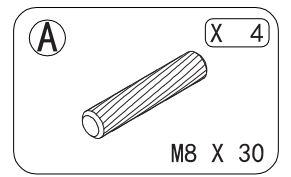
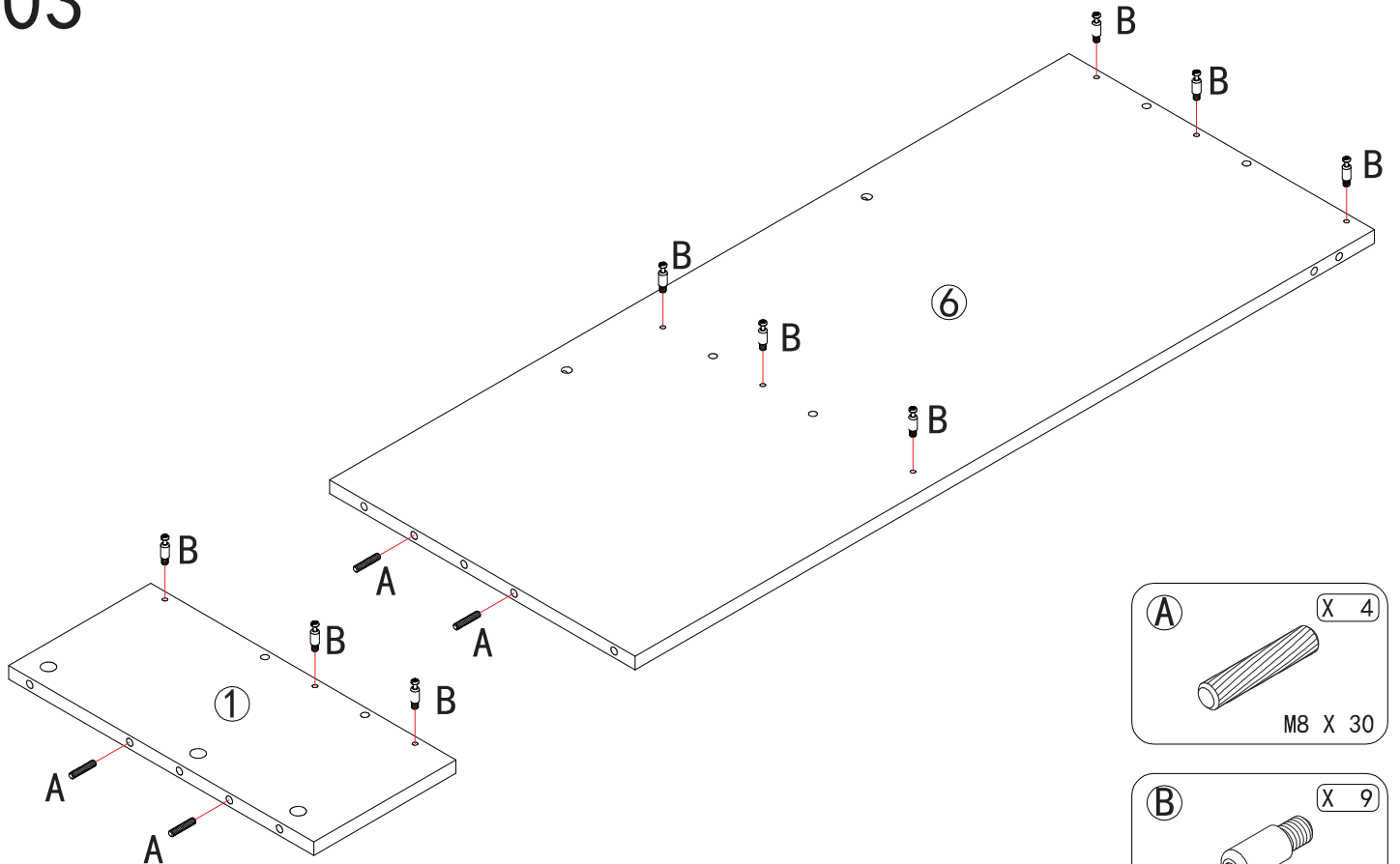

04

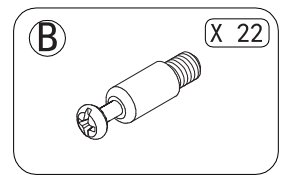
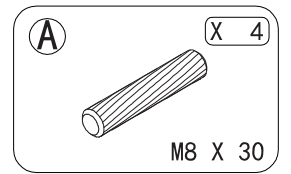
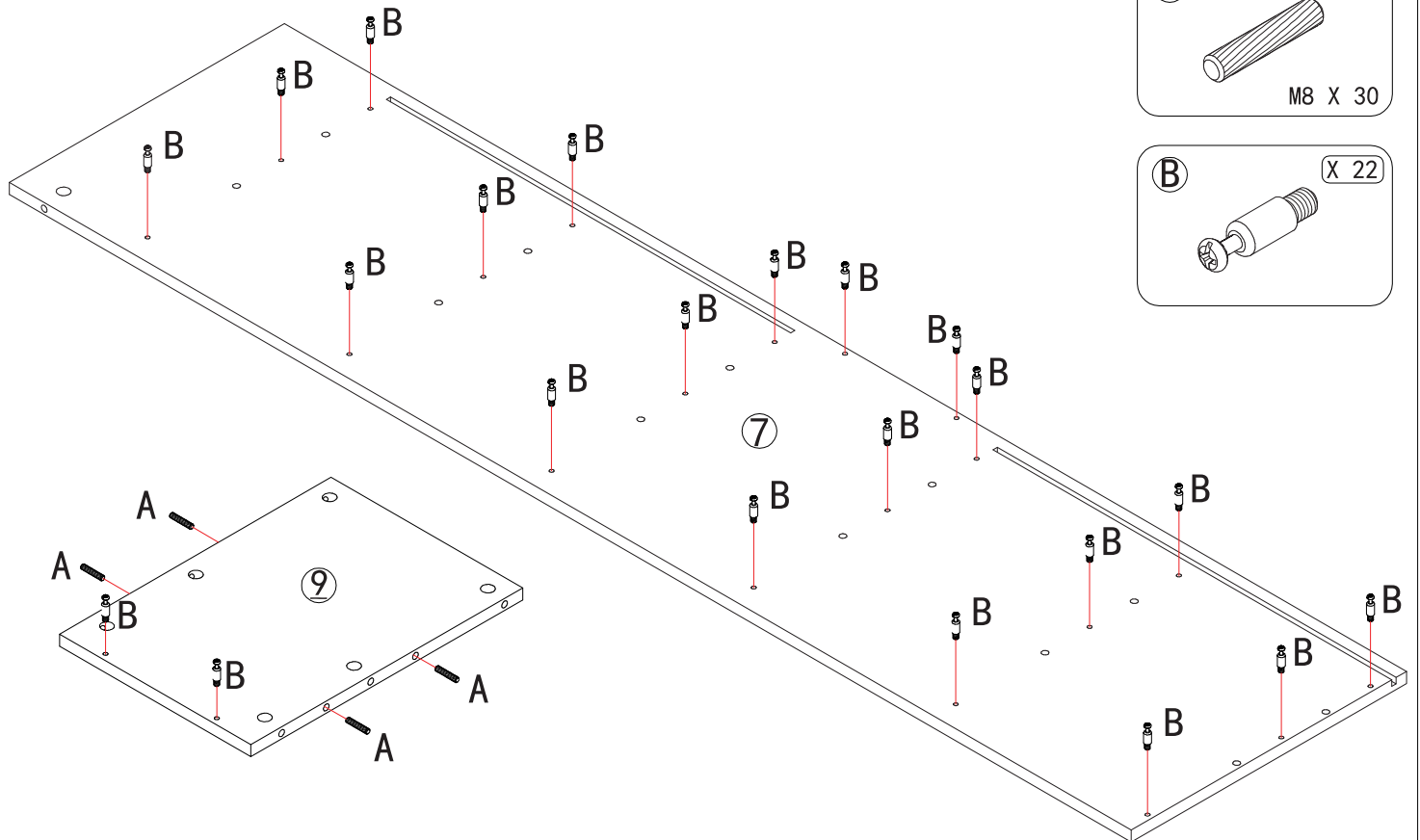

05

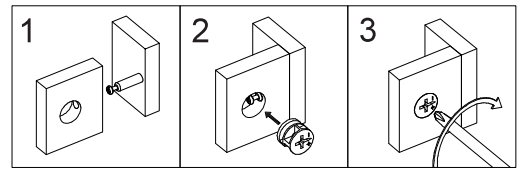
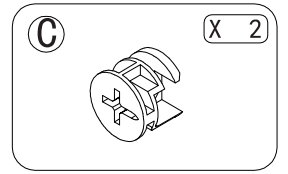
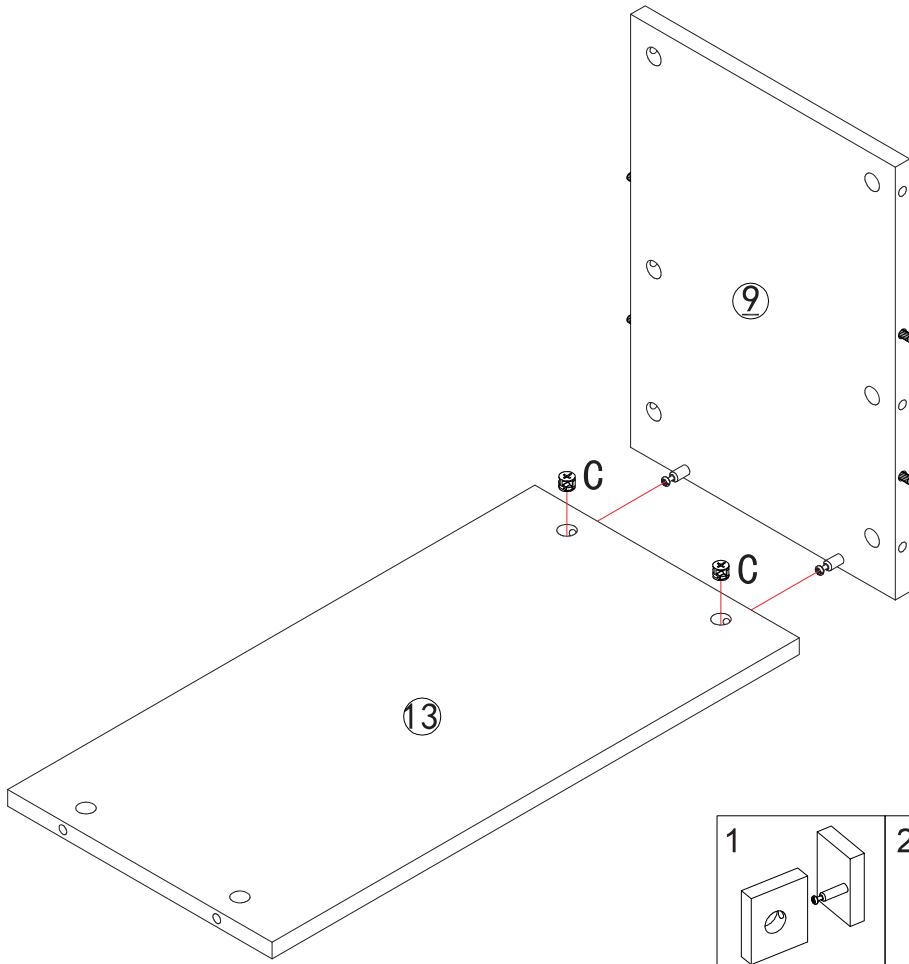

06

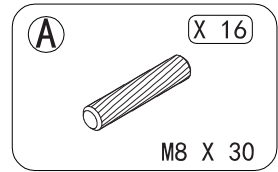
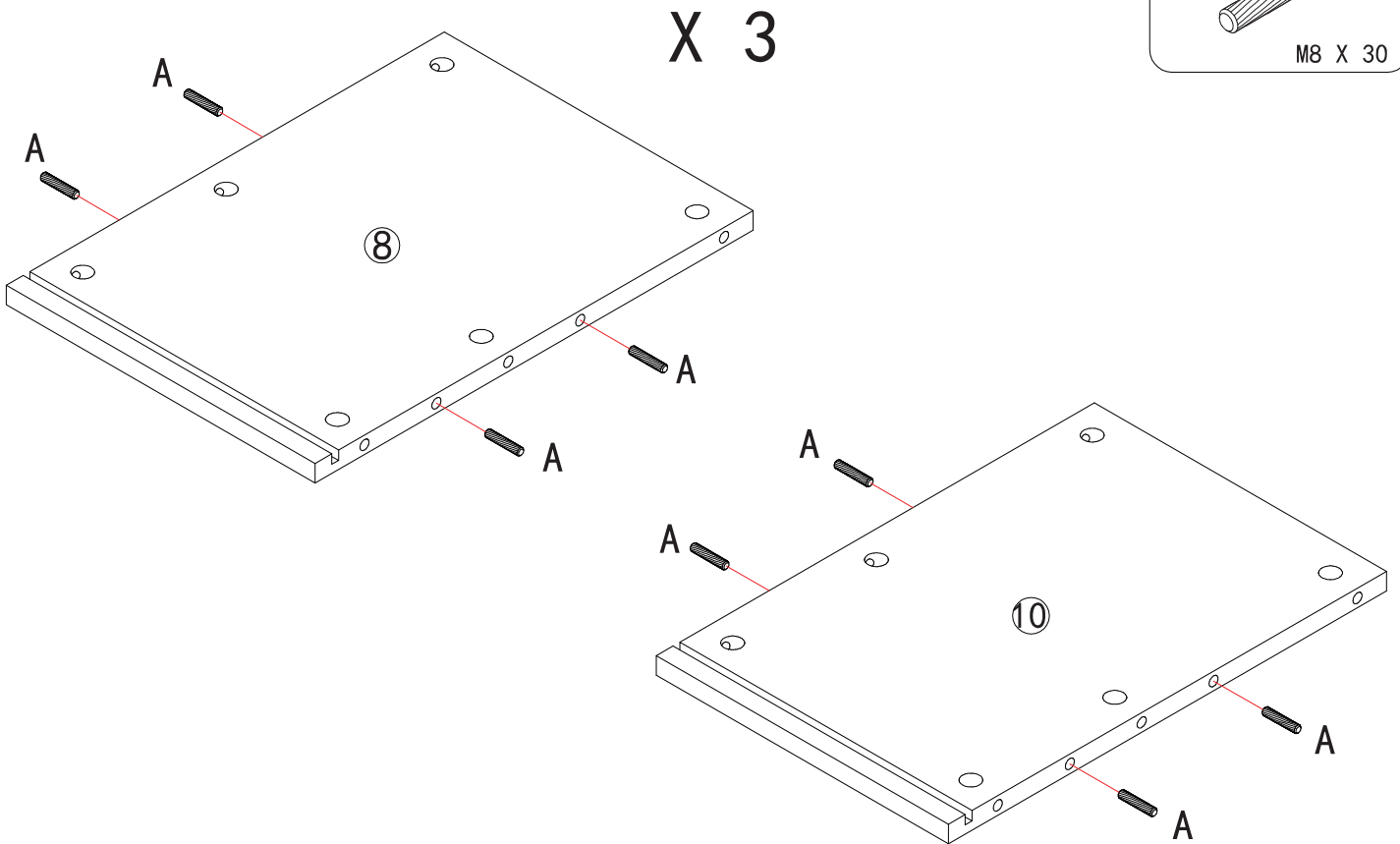

07

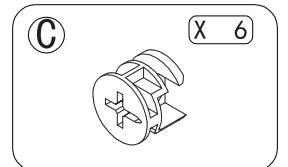
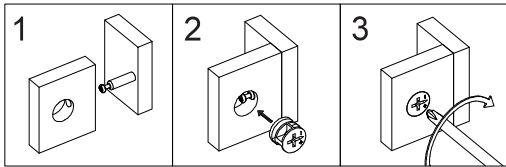
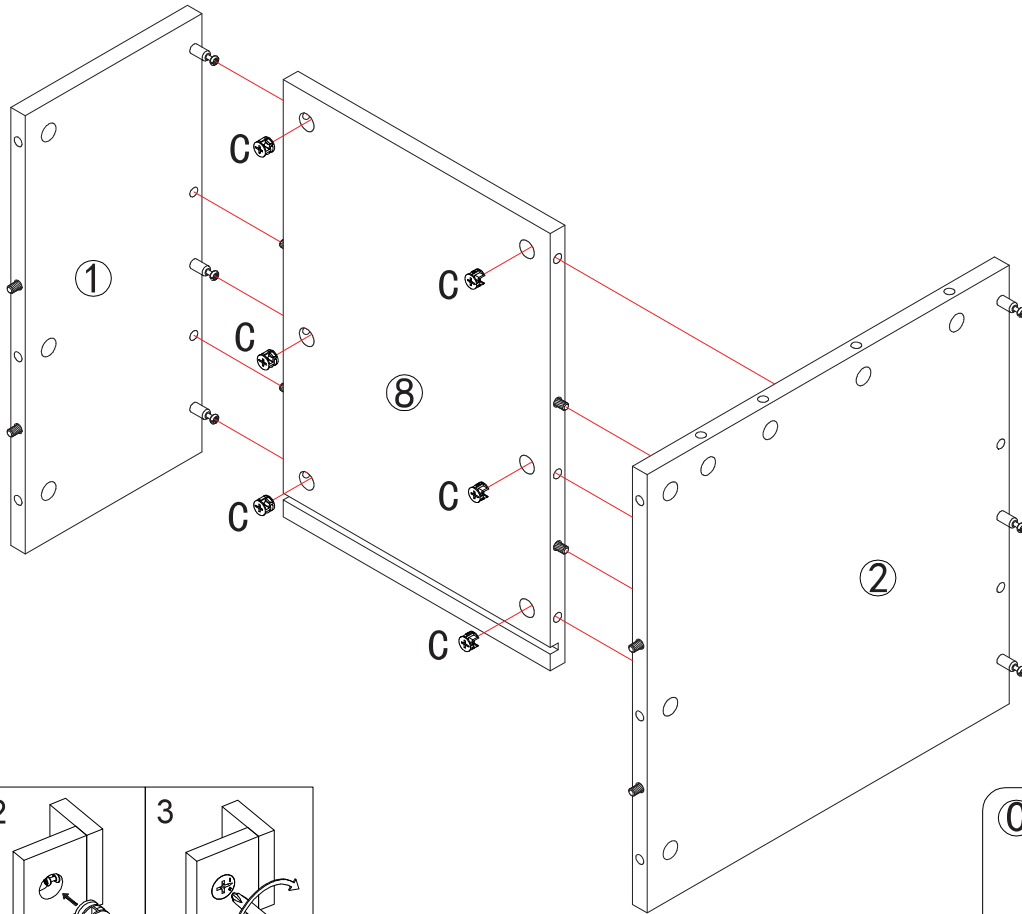

08

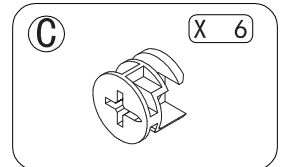
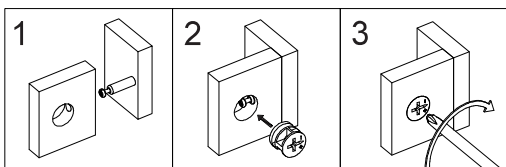
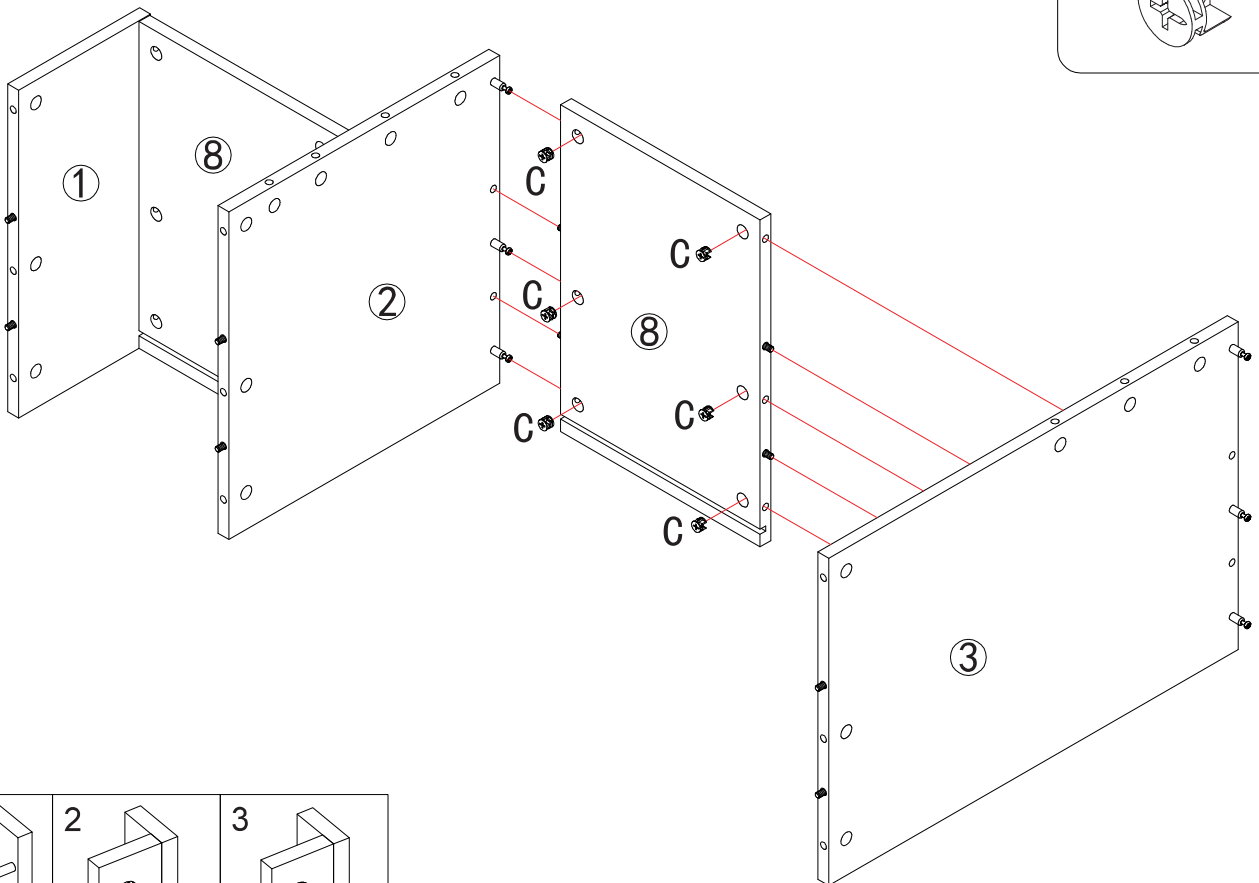

09

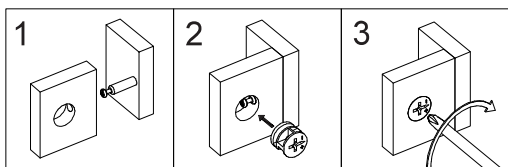
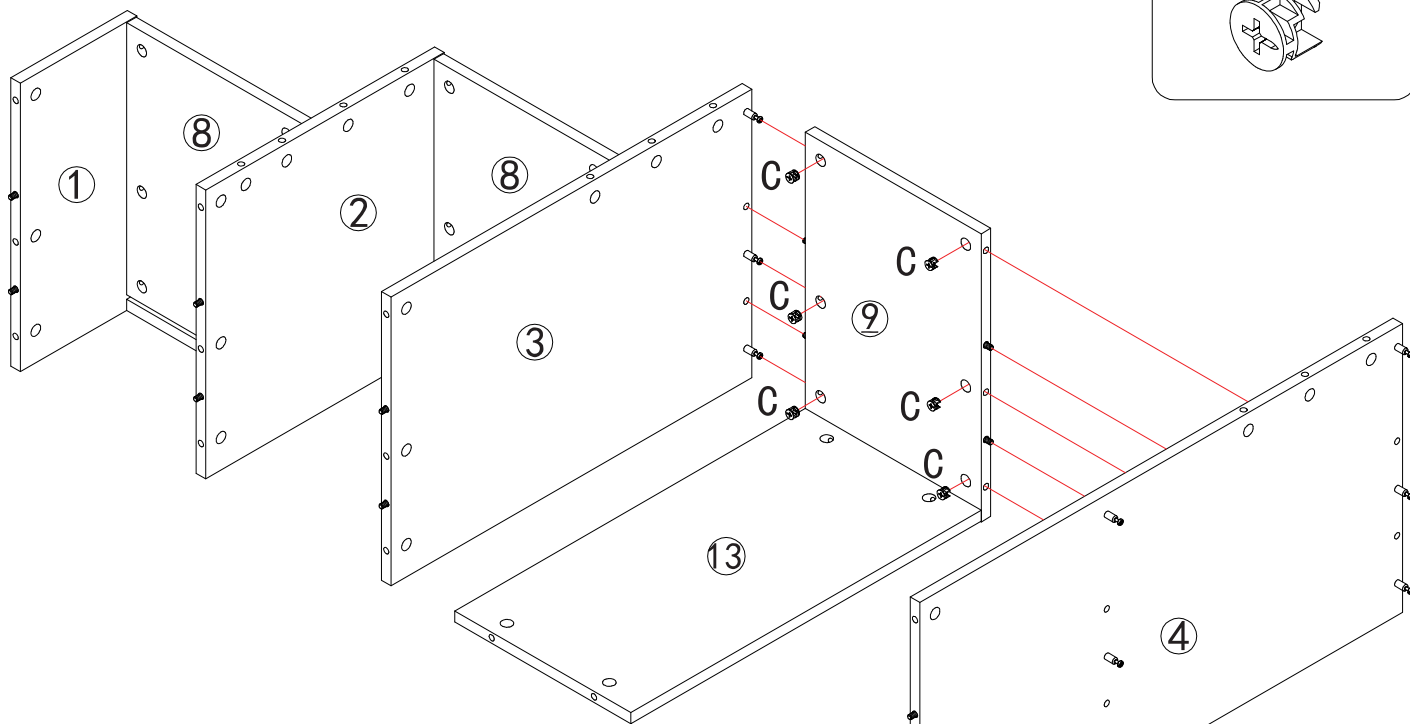
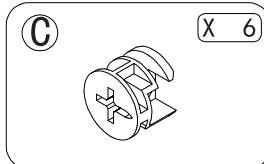

10

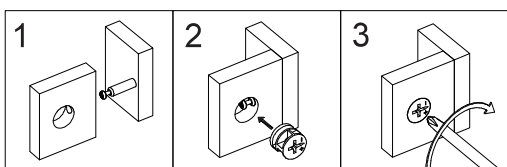
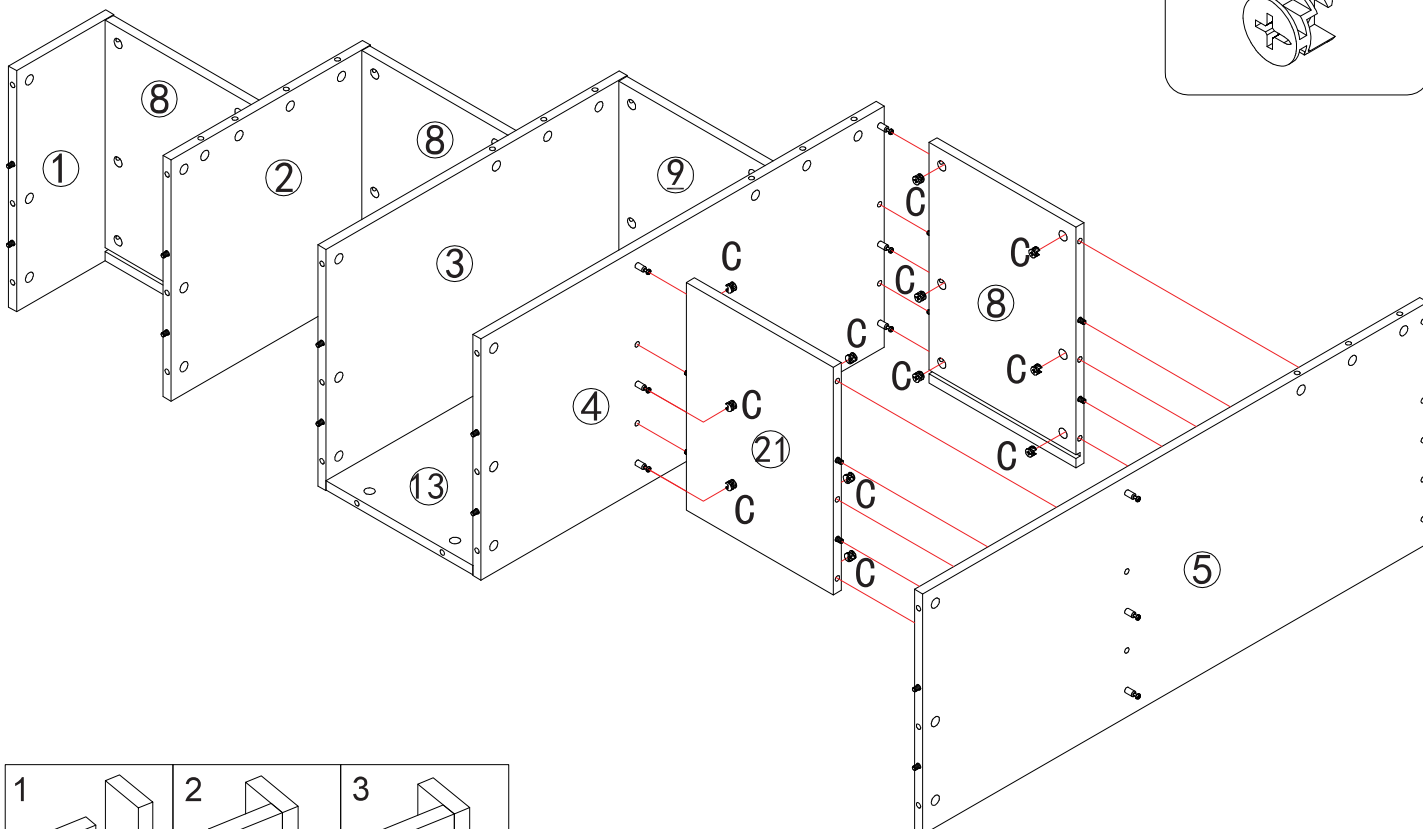
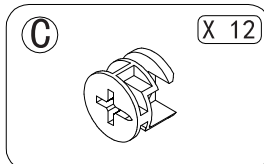

11

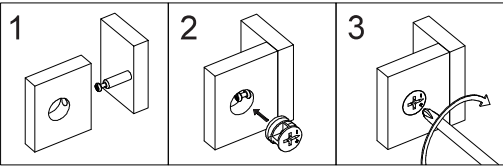
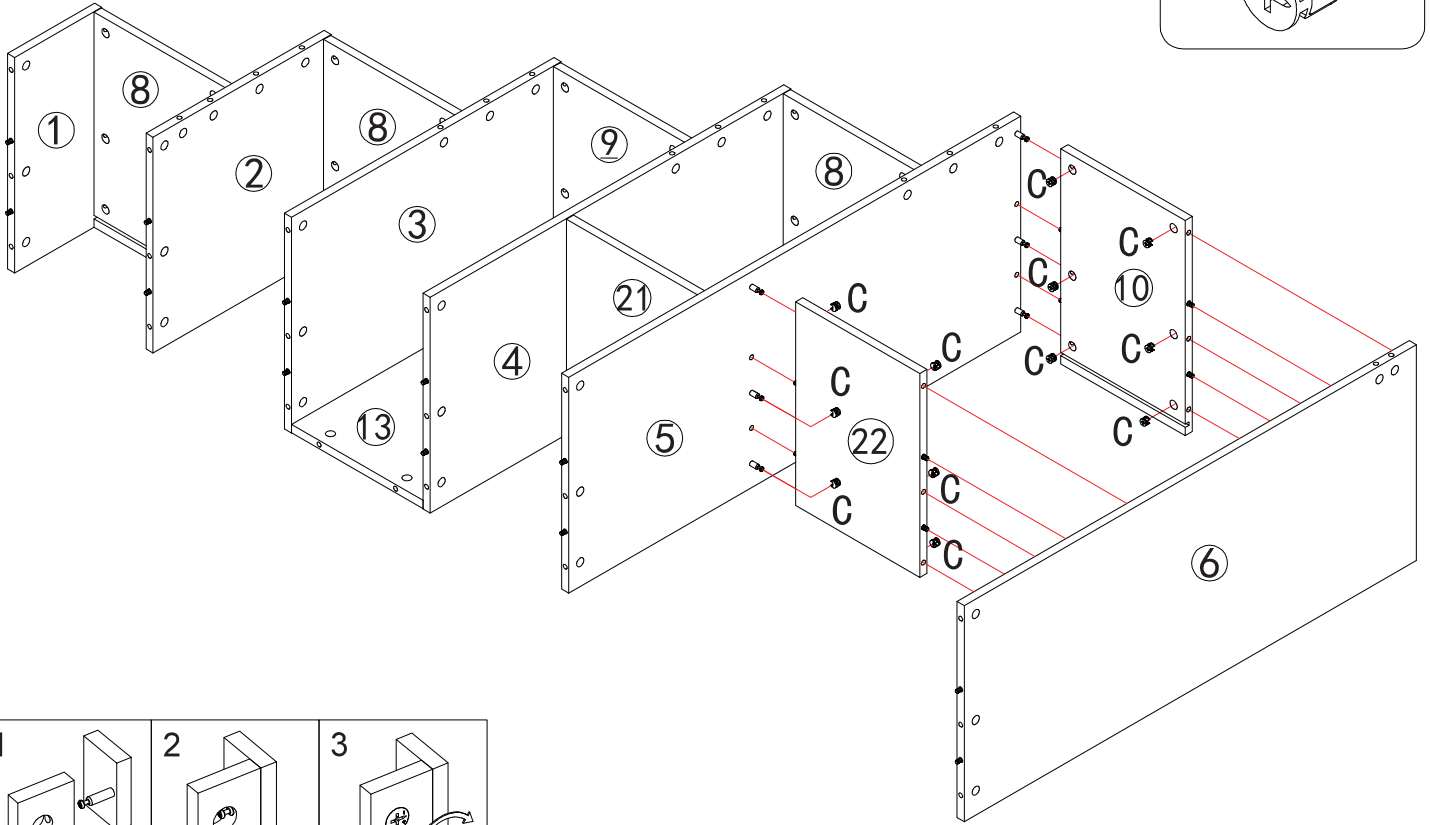
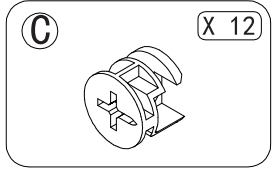

12

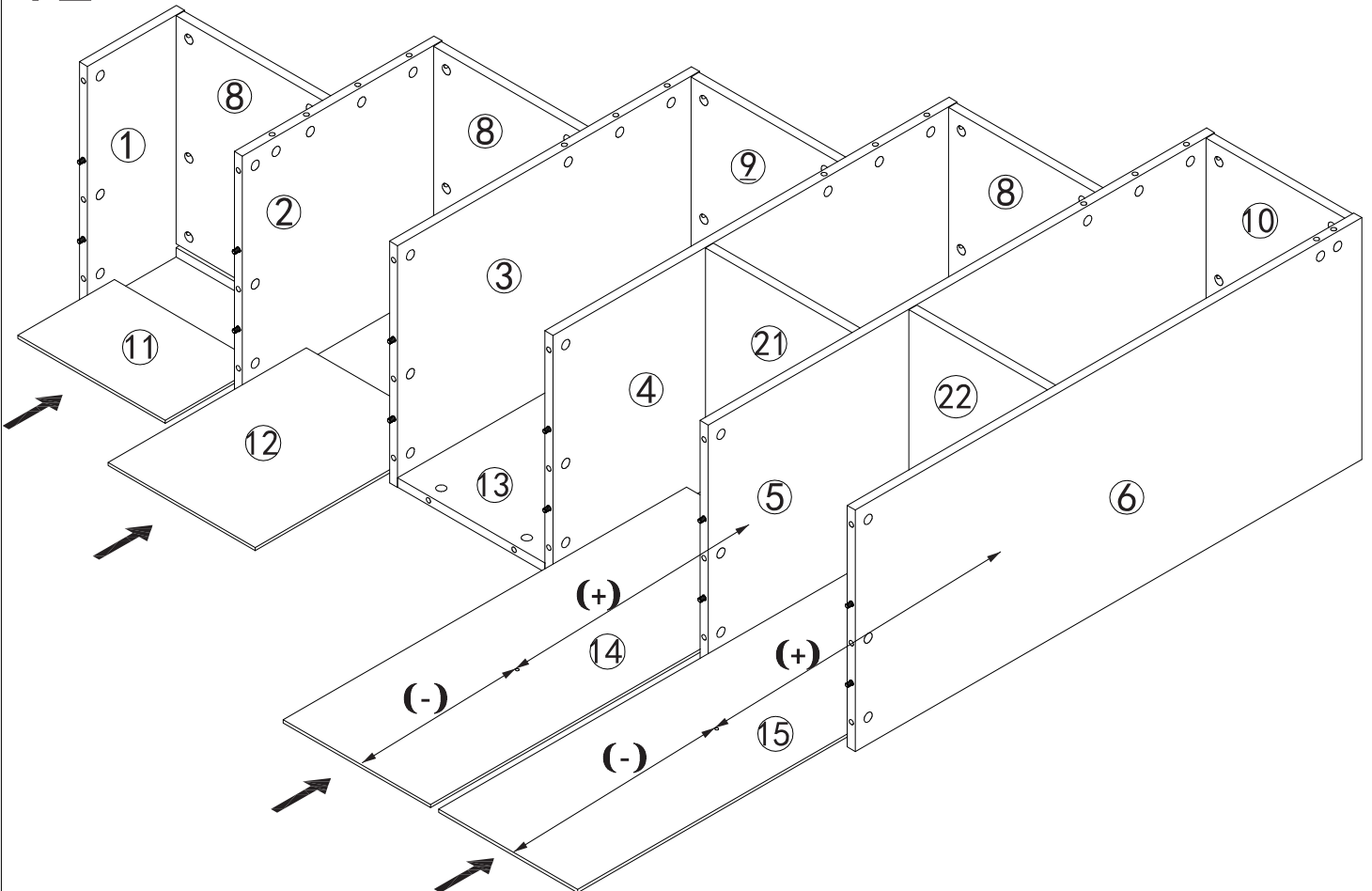

13

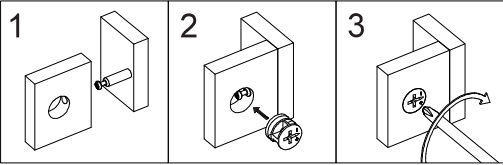
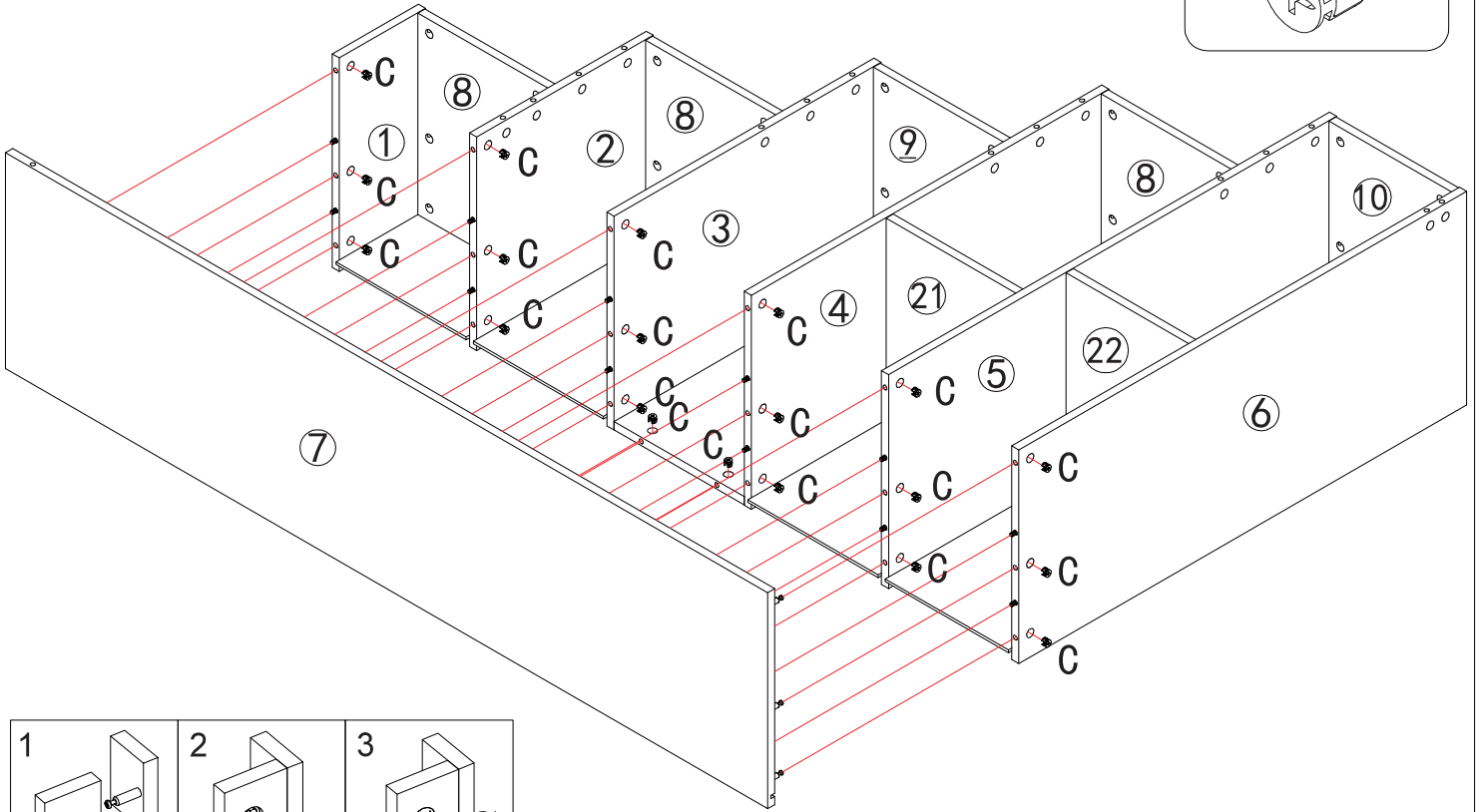
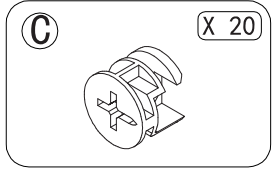

14

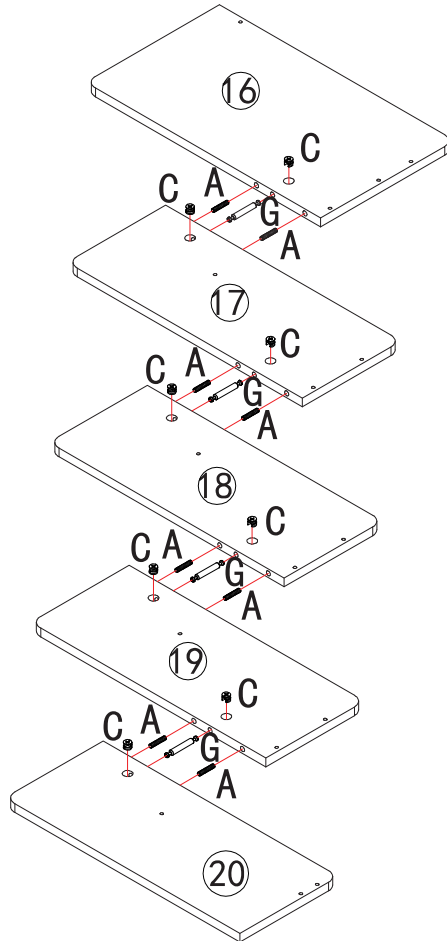
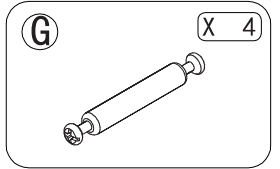
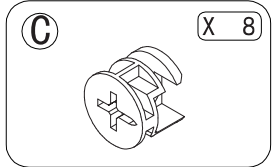
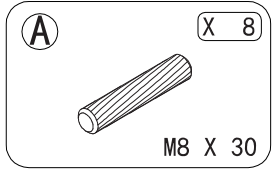

15

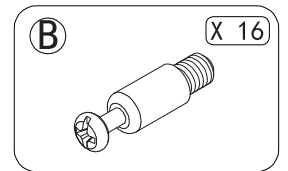
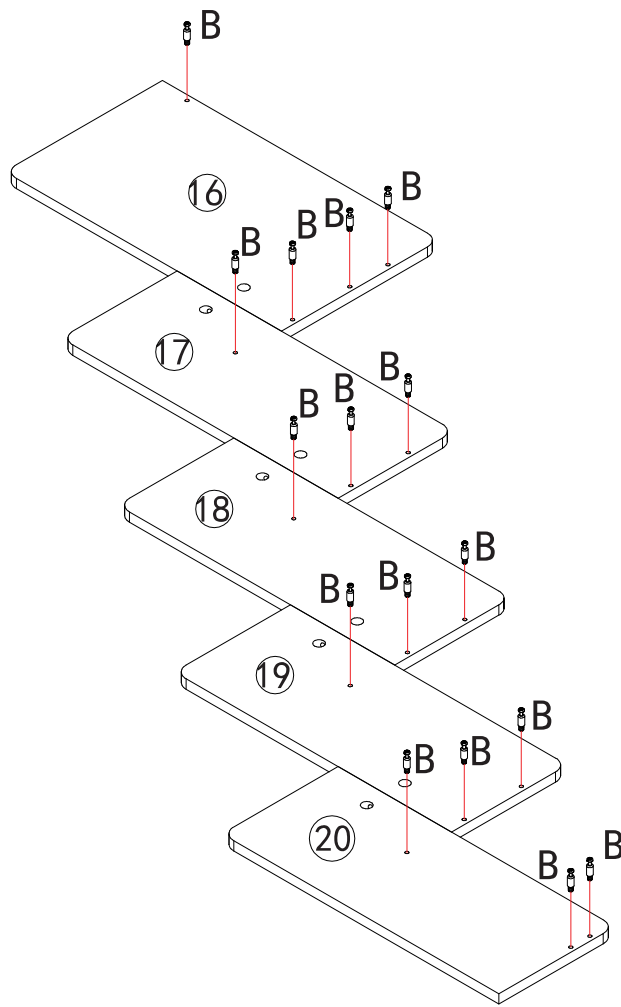

16

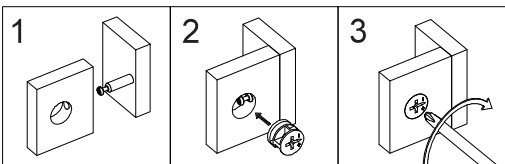
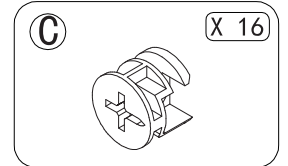
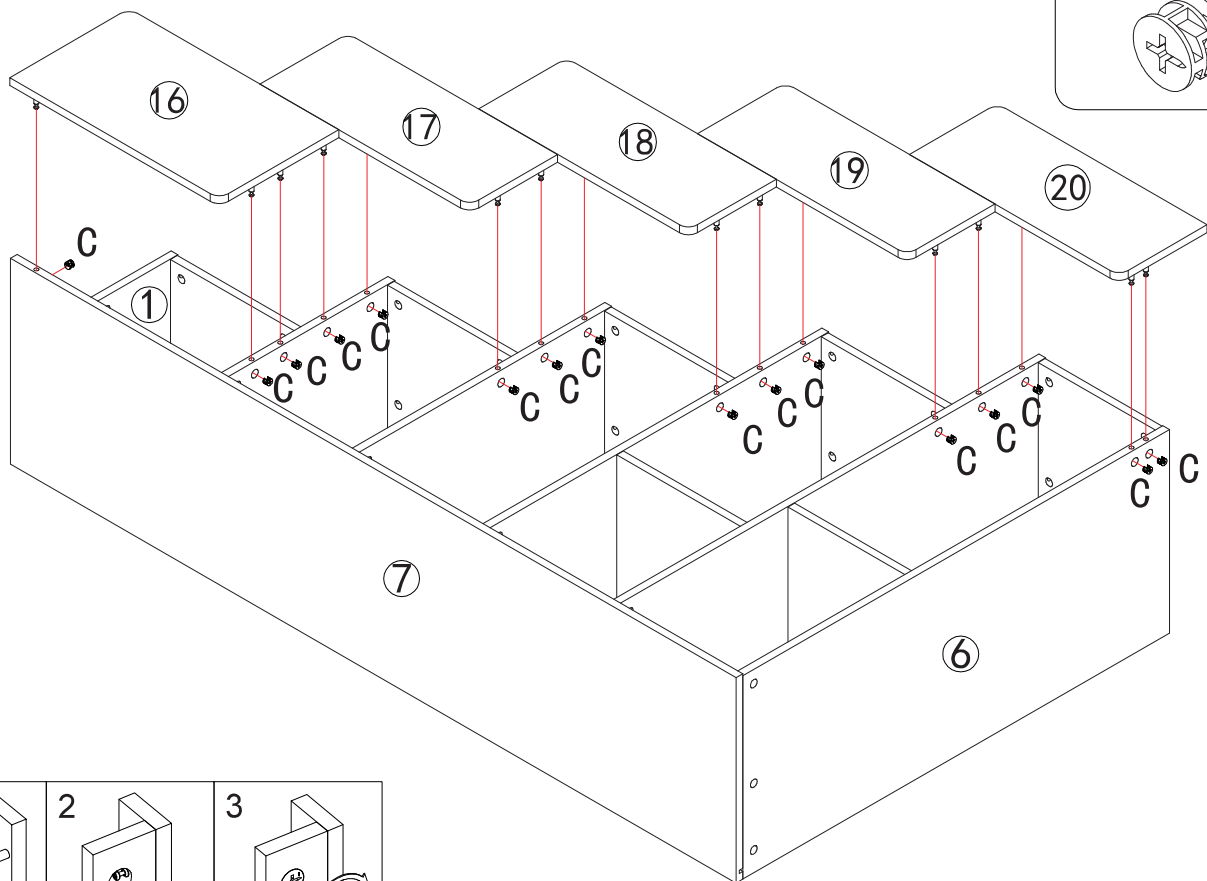

17

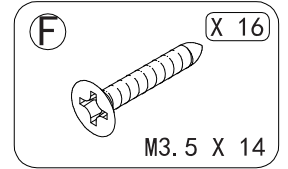
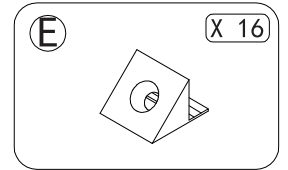
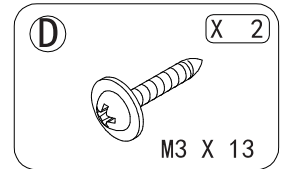
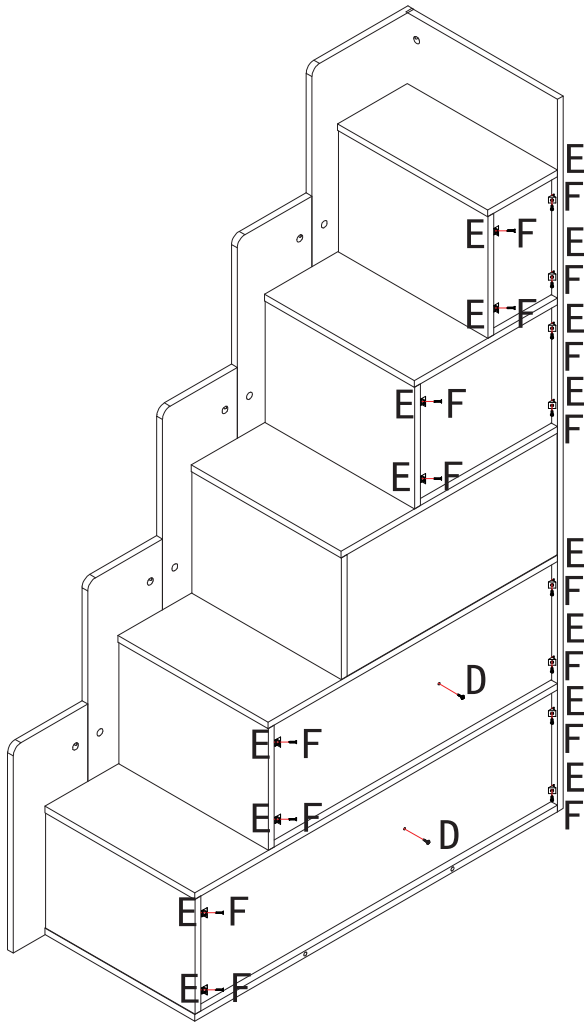

18

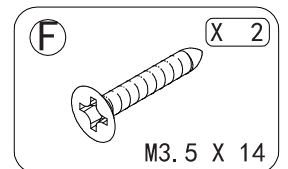
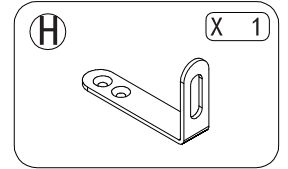
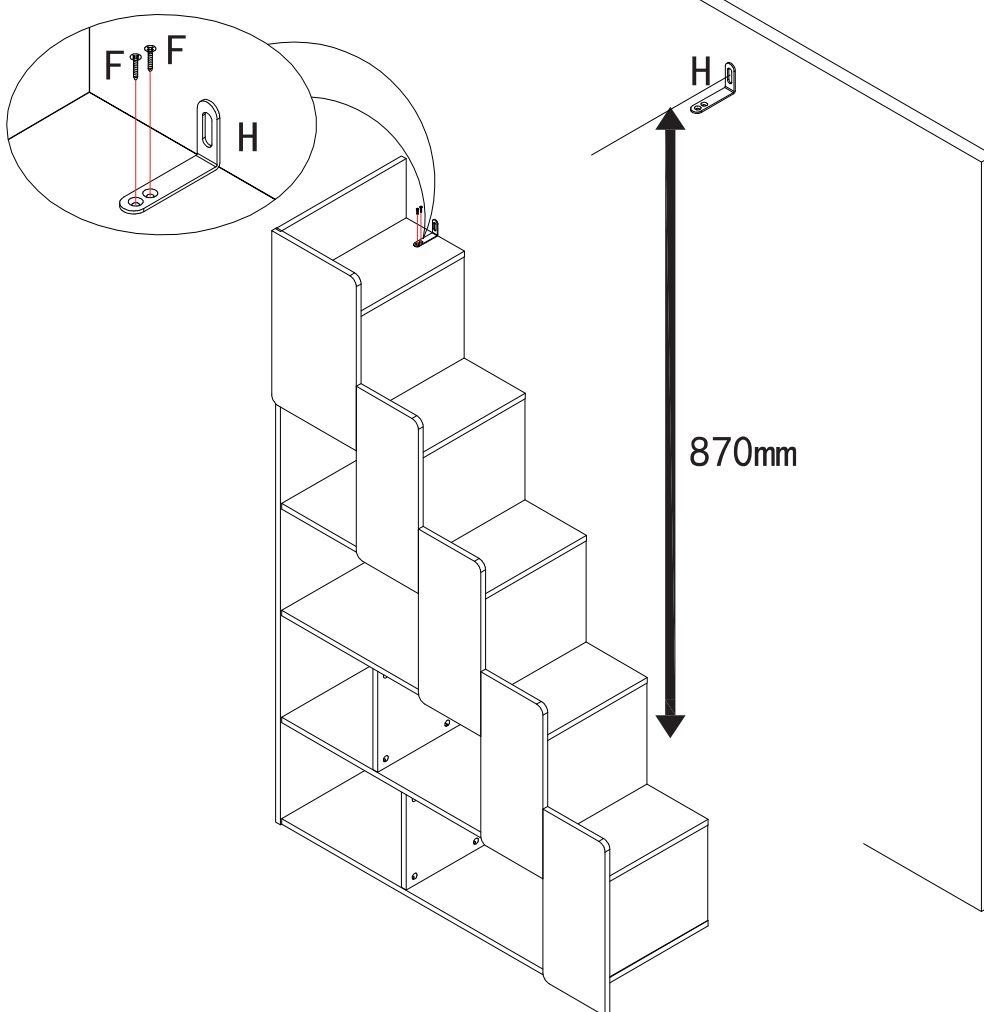

OPTION -1

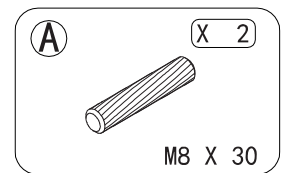
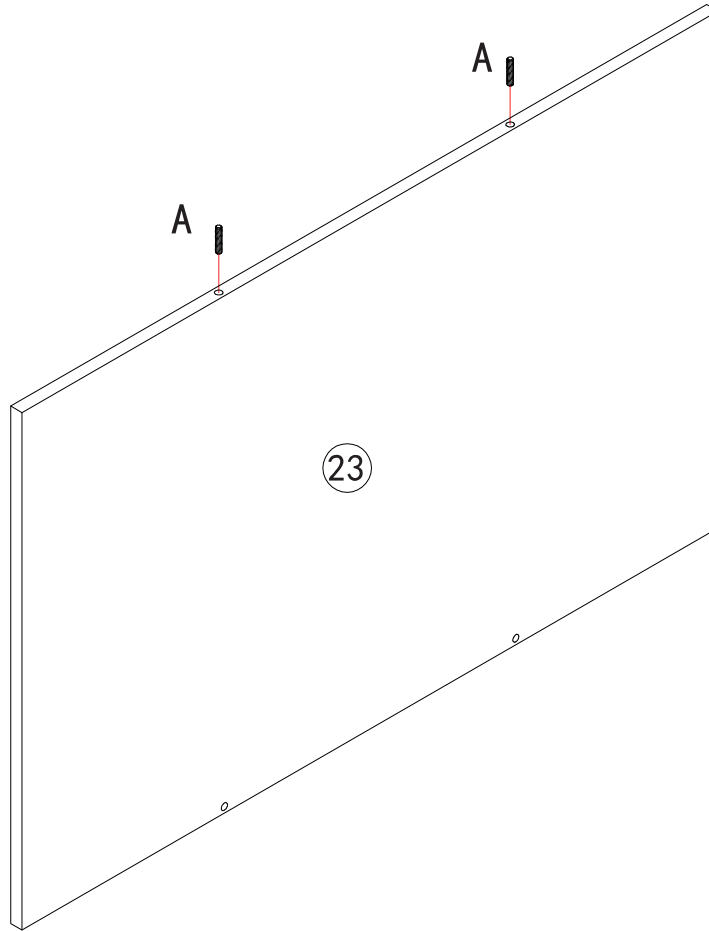

OPTION -2

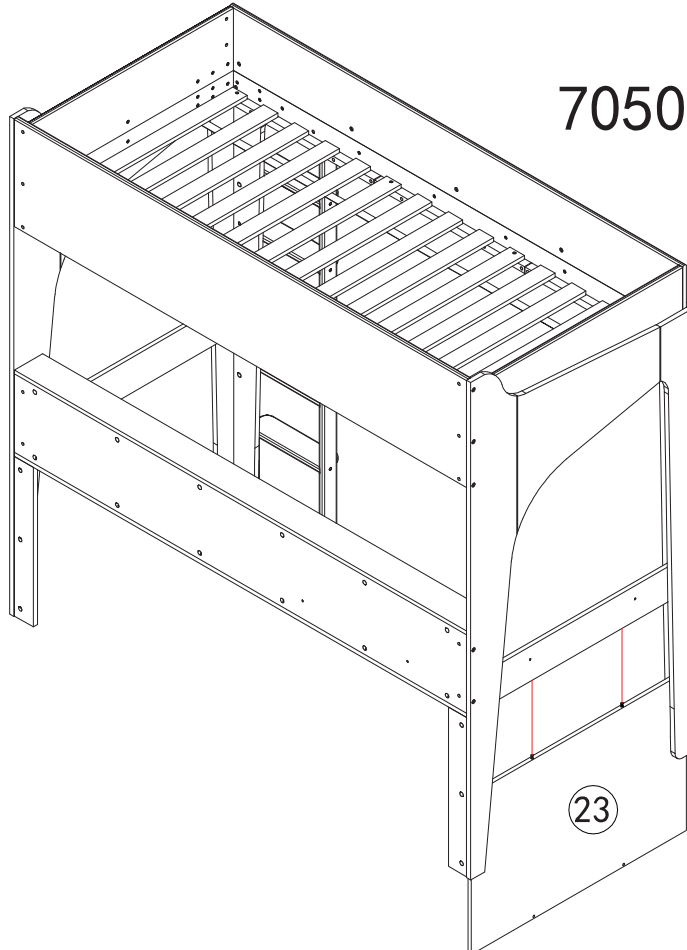

70501 0674

OPTION -3

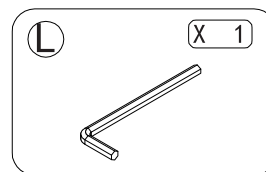
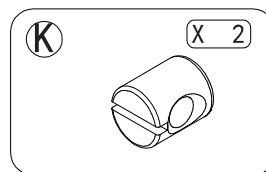
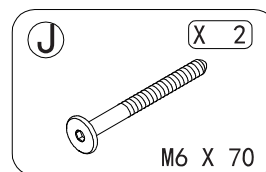
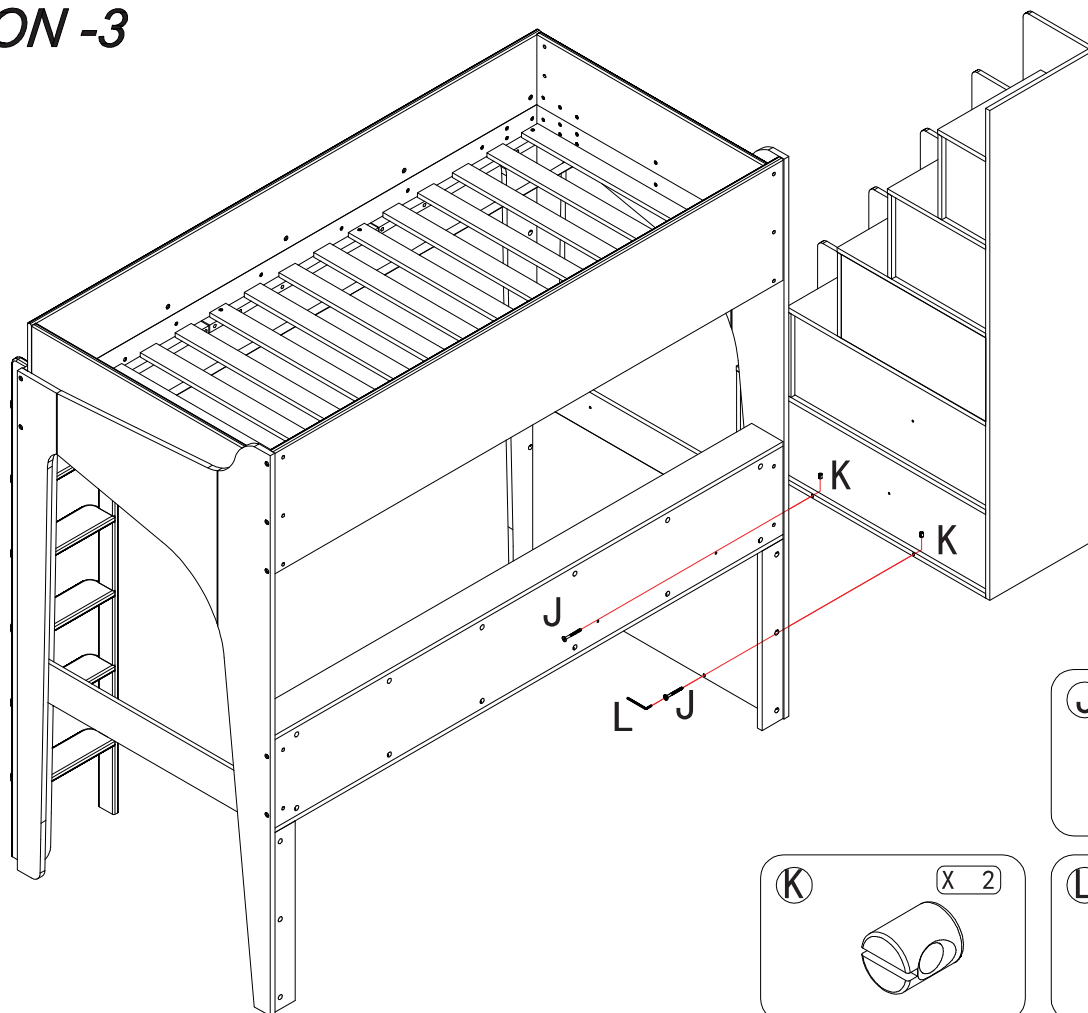

OPTION -4

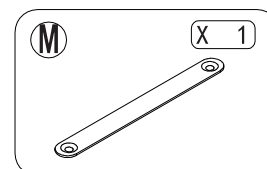
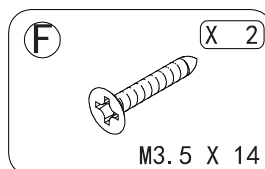
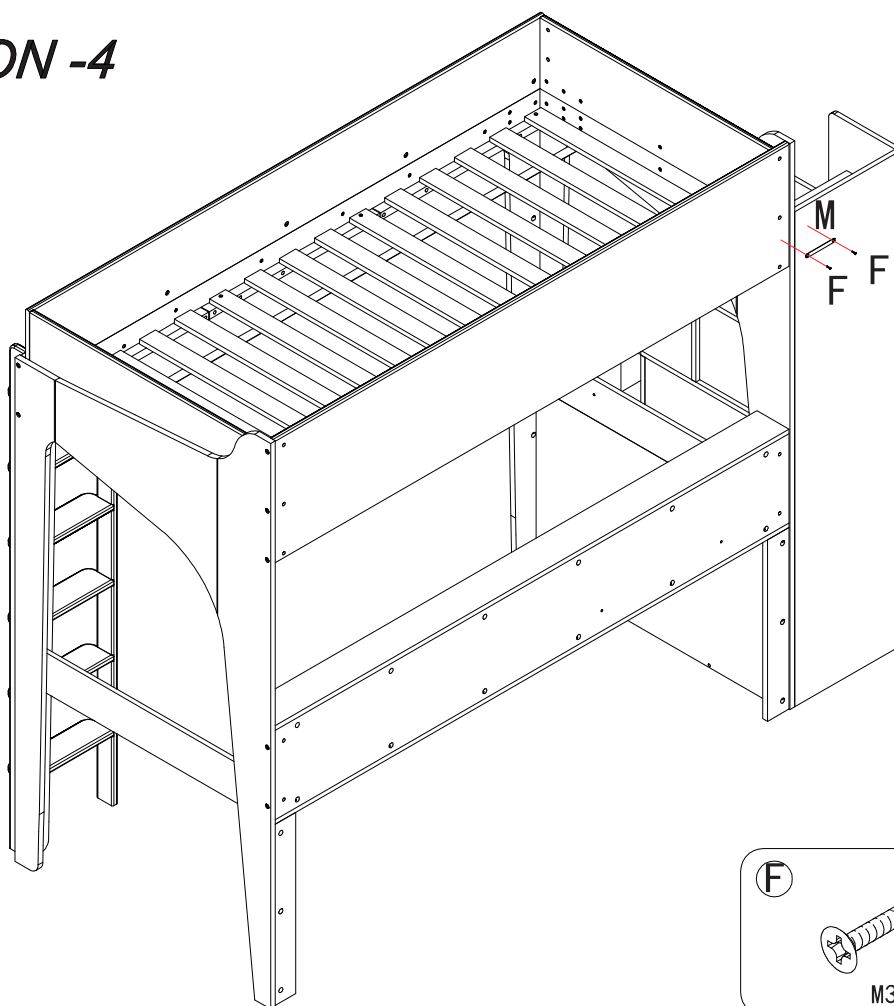

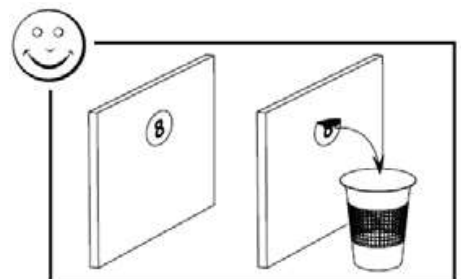
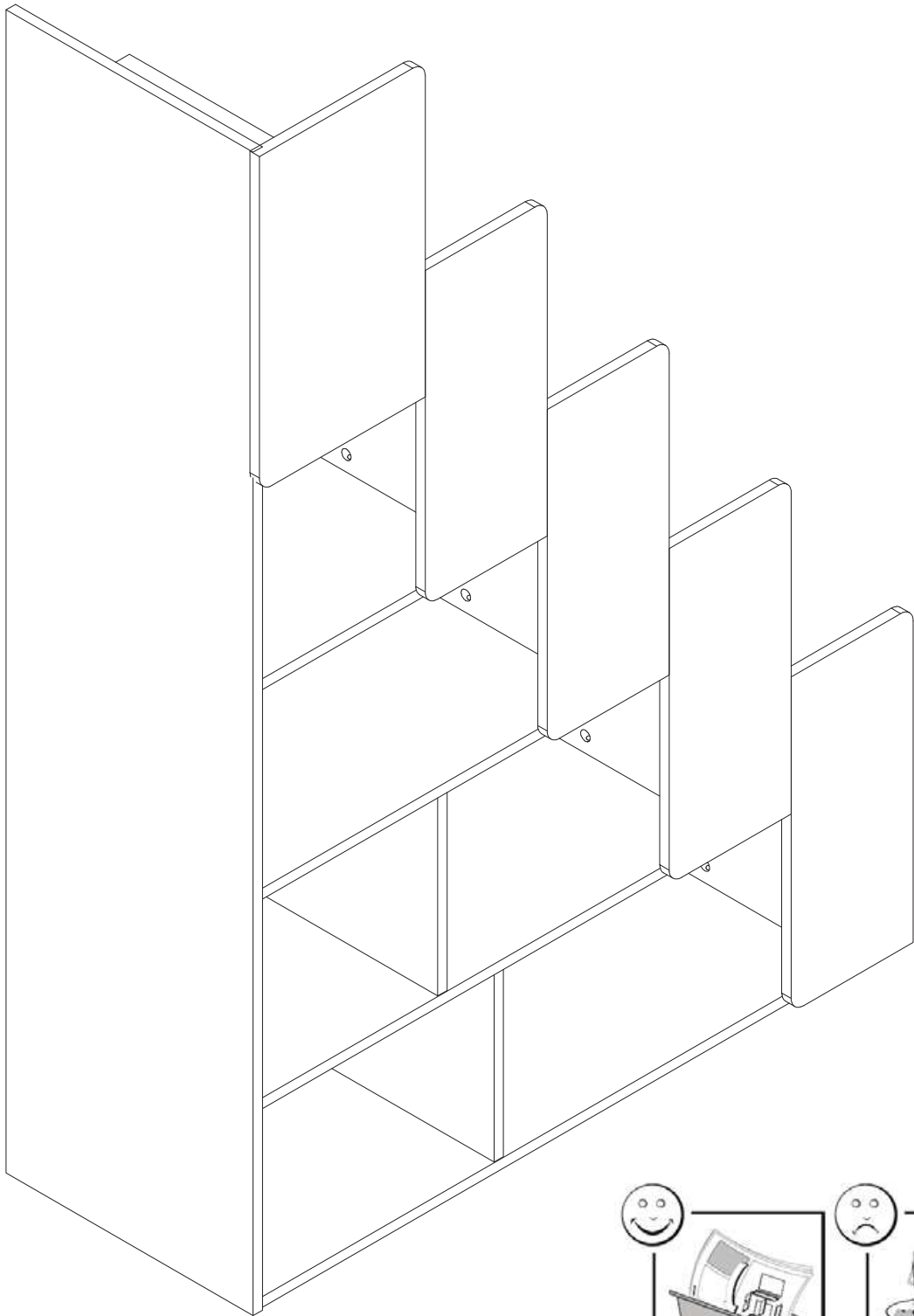

INFORMATIONS Á CONSERVER.

ATTENTION : TENIR LES VIS ET LES PETITS ÉLÉMENTS ET SACHETS HORS DE PORTÉE DES ENFANTS.

ATTENTION ! BIEN IDENTIFIER LES ÉLÉMENTS AVANT DE COMMENCER LE MONTAGE.

A MONTER PAR UN ADULTE.

NE PAS SE SERVIR DU MEUBLE COMME D'UNE ÉCHELLE.

EN CAS DE PROBLÈME, CONTACTEZ NOTRE SERVICE APRÈS VENTE.

NE PAS UTILISER VOTRE ARTICLE LORSQUE L'UN DE SES ÉLÉMENTS EST CASSÉ OU MANQUANT.

KEEP THIS INFORMATION FOR FUTURE REFERENCE.

CAUTION : KEEP ALL SCREWS, SMALL PARTS AND PLASTIC BAG OUT OF THE REACH OF SMALL CHILDREN.

CAUTION : CHECK ALL PARTS BEFORE ASSEMBLING.

TO BE ASSEMBLED BY AN ADULT.

NOT TO USE THIS ARTICLE AS A SCALE.

SHOULD ANY PROBLEMS ARISE, PLEASE CONTACT OUR AFTER SALES SERVICE.

NEVER USE YOUR ITEM IF ANY OF ITS PARTS ARE BROKEN OR MISSING.

INFORMAÇÃO A CONSERVAR.

PRECAUÇÃO : MANTENHA PEÇAS OS PARAFUSOS, ACESSÓRIOS PEQUENOS E SACO DE PLÁSTICO FORA DO ALCANCE DAS CRIANÇAS.

ATENÇÃO ! IDENTIFIQUE OS PARAFUSOS ANTES DE COMEÇAR A MONTAGEM.

A SER MONTADO POR UM ADULTO.

NAO UTILIZAR ESTE ARTIGO COMO ESCADOTE.

PARA QUALQUER ESCLARECIMENTO, CONTACTE OS NOSSOS SERVIÇOS ATRAVÉS DO TELEPHONE.

NÃO UTILIZAR O ARTIGO SE UM DOS ELEMENTOS ESTÁ EM FALTA OU DANIFICADO.

GUARDAR ESTA INFORMACIÓN PARA FUTURAS REFERENCIAS.

ATENCIÓN : MANTENER LOS TORNILLOS, LOS PEQUEÑOS ELEMENTOS Y BOLSITAS FUERA DEL ALCANCE DE LOS NIÑOS.

¡ ATENCIÓN ! IDENTIFICAR LOS ELEMENTOS ANTES DE EMPEZAR EL MONTAJE.

A MONTAR POR UN ADULTO.

NO UTILIZAR ESTE ARTÍCULO COMO ESCALERA.

SI TIENE PROBLEMAS, CONTACTAR NUESTRO SERVICIO POSTVENTA.

NO UTILIZAR ESTE ARTÍCULO SI UNO DE LOS ELEMENTOS FALTA O ESTA ROTO.

AUFZUBEWAHRENDE INFORMATIONEN.

ACHTUNG : DIE SCHRAUBEN UND KLEINEN TEILE AUSSERHALB DER REICHWEITE VON KINDERN LAGERN.

ACHTUNG : VOR MONTAGEBEGINN ALLE TEILE IDENTIFIZIEREN.

VON EINEM ERWACHSENEN ZU MONTIEREN.

DIESEN ARTIKEL NICHT ALS LEITER BENUTZEN.

IM PROBLEMFALL IHREN KUNDENDIENST ANRUFEN.

IHREN ARTIKEL NICHT BENUTZEN, WENN EINES SEINER BESTANDTEILE BESCHÄDIGT IST ODER FEHLT.

CONSERVARE LE ISTRUZIONI PER FUTURO UTILIZZO.

ATTENZIONE ! TENERE LE VITI ED I COMPONENTI DI PICCOLE DIMENSIONI LONTANO DALLA PORTATA DEI BAMBINI.

ATTENZIONE ! CONTROLLARE I PEZZI PRIMA DEL MONTAGGIO.

IL MONTAGGIO DEVE ESSERE ESEGUITO DA UN ADULTO.

NON UTILIZZARE QUESTO ARTICOLO A GUIA DI SCALA.

IN CASO DI NECESSITÀ CONTATTARE IL NOSTRO SERVIZIO POST-VENDITA.

L'ARTICOLO NON DEVE ESSERE UTILIZZATO IN CASO DI ELEMENTI MANCANTI O DANNEGGIATI.

INFORMATIE OM TE BEWAREN.

WAARSCHUWING : SCHROEVEN EN KLEINE ELEMENTEN EN ZAKJTES BUITEN BEREIK VAN KINDEREN HOUDEN.

LET OP ! DE ELEMENTEN GOED IDENTIFICEREN ALVORENS MET DE MONTAGE TE BEGINNEN.

MOET DOOR EEN VOLWASSENE WORDEN GEMONTEERD.

DIT ARTIKEL NIET ALS LADDER GEBRUIKEN.

NEEM BIJ PROBLEMEN CONTACT OP MET ONZE KLANTENSERVICE.

UW ARTIKEL NIET GEBRUIKEN WANNEER EEN VAN DE ONDERDELEN KAPOT IS OF ONTBREEKT.

Distribué par / Distributed by / Distribuido por / Distribuido por / Vertrieben von / Distribuido da : / Gedistribueerd door

VERTBAUDET SAS
216, Rue Winoc Chocquet
59200 Tourcoing - FRANCE